

Accessories



Patient Monitor Mounting Solutions

Amico



About Us

Amico has been an industry leader in the medical equipment-manufacturing sector since 1974. We've worked hard for our reputation as an innovator in the medical industry, and Amico Accessories Inc. has created a line of Healthcare Mounting Solutions that suit the needs of healthcare providers. Meeting and exceeding standards set by FDA, ISO, OSHPD, UL 60601 and VESA, Amico is the only mounting solutions provider that can offer the peace of mind that comes with knowing the product you receive meets the highest of standards. Amico Accessories Inc. strives to provide caregivers with reliable and attractive workflow solutions. Our products are compatible with every major manufacturer so they work the way you expect them to with no headaches.



Clinical Engineering

Merging lifesaving equipment with your hospital's communications backbone leads to a safer environment for your patients. With Amico, you can take comfort knowing that every product we design, build and sell is constructed to stand up to the demands of the healthcare industry. Our solutions are backed by an industry leading, all-inclusive warranty. With upgrade-friendly solutions, we can adapt to your constantly changing technological needs. In addition, as a single point of contact for all medical device mounting, we make it easy to find a solution that works for your specific needs.

IT

Implementing EMR can cause headaches in terms of both budget and time. We do everything we can to take the complexity out of the process by bringing you solutions that work. Our products ship fully assembled, with no complicated instructions to worry about. We design all of our products to be "plug and play." They install in seconds so no time or money is wasted getting them up and running. You can rest easy knowing that our cable management and solutions for any hardware (tablets, PCs, laptops and all-in-ones) will fit seamlessly into your implementation.

Nursing

We understand that as a healthcare professional your main concern is your patient. The tools you use are crucial when caring for your patient, but they shouldn't dominate your workspace and get in the way of human interaction. Our ergonomically friendly mounting solutions are designed to enhance your workflow and help you take control of your workspace, allowing for more contact with your patients. Amico products feature easy-to-clean, anti-microbial surfaces that help reduce the spread of infection from patient to patient.

Compatible Mounting Solutions

Available For...

Advantech
 Alaris
 Analogic
 CAS Medical
 Capsule
 Colin
 Criticare
 Datascope Patient Monitoring
 Datex-Ohmeda
 Dräger Medical
 Elo Touch

Fukuda Denshi
 GE Healthcare
 Hoana Medical
 Invivo
 Ivy Biomedical
 Larsen & Toubro
 Masimo
 Mediana
 Medtronic
 Mennen Medical
 Mindray

Nellcor
 Nihon Kohden
 Nonin
 Oridion
 Philips Medical
 Schiller
 Spacelabs Medical
 Welch Allyn
 Witt
 Zoll

We work with you to create mounting solutions for any brand, make or model

Visit Our Website to Find the Matching Solution to Your Monitor Needs

www.amico.com

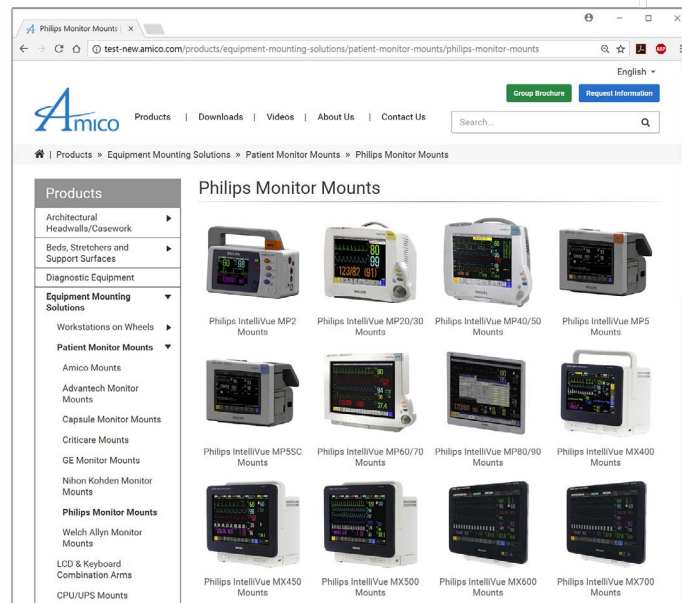

Check Out More of Our Product Brochures!



Healthcare Information Technology
 Mounting Solutions

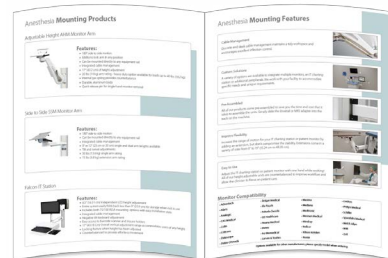

Anesthesia
 Mounting Solutions

AHM

Adjustable Height Monitor Arm



Channel or Rail Adapters

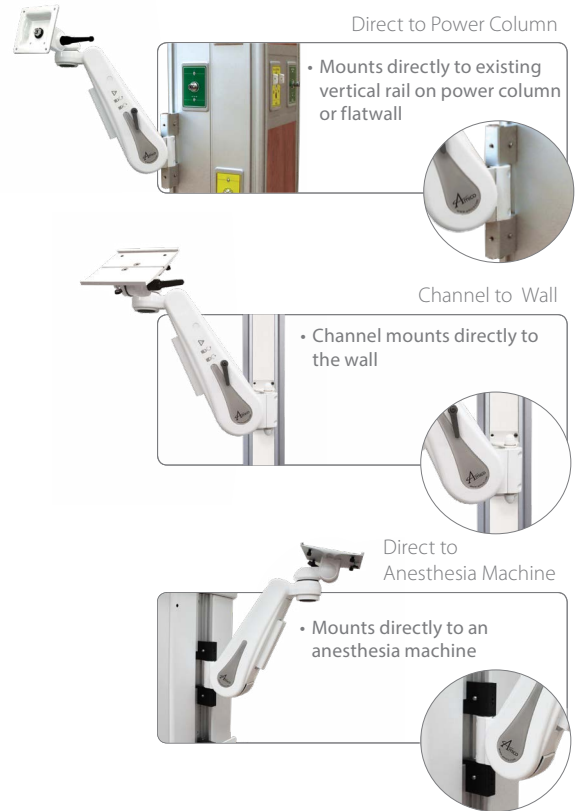

AHM Extensions - Adjustable Height Models



Customize With Color

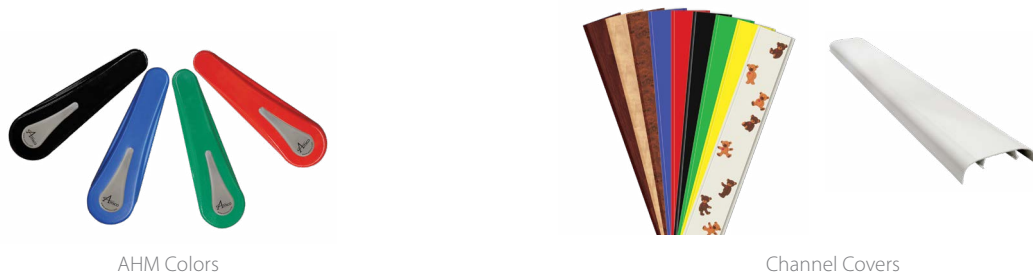

SSM

Side to Side Monitor Arm

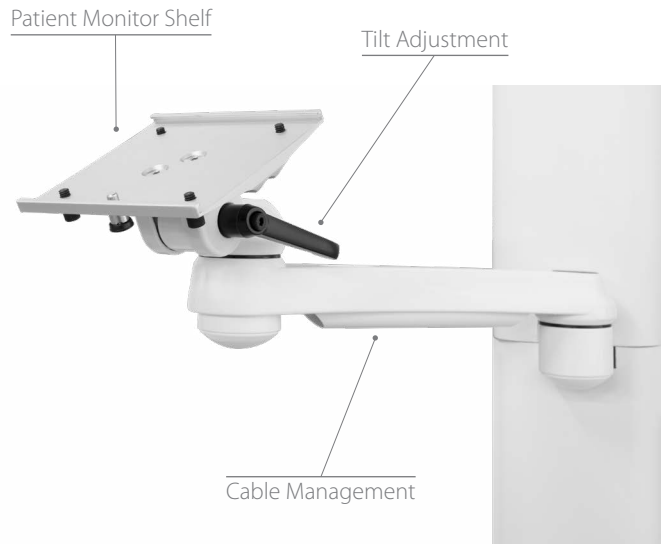

Channel or Rail Adapters

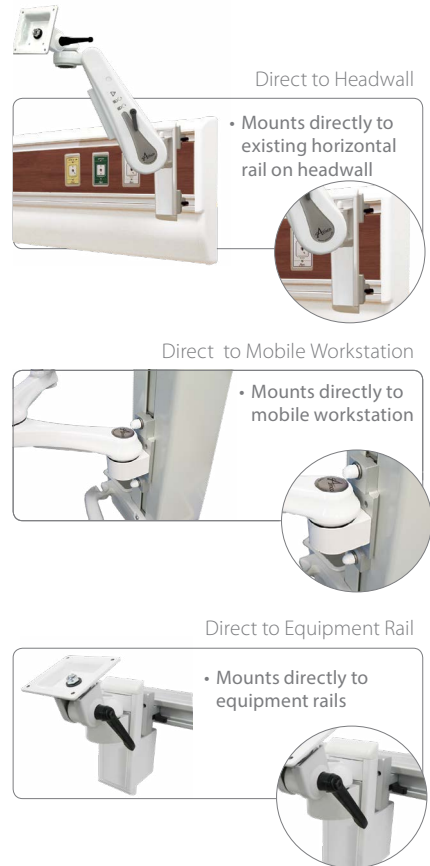

SSM Extensions - Side to Side Models



SSM Flush



SSM 9" (22.9 cm) Single



SSM 12" (30.5 cm) Single



SSM 9" x 9" Double
(22.9 cm x 22.9 cm)



SSM 12" x 12" Double
(30.5 cm x 30.5 cm)

Patient Shelf Monitor



5" (12.7 cm) Shelf with 30° Tilt Limit



6" (15.2 cm) Drop on Shelf



Philips IntelliVue Shelf



Accessory Add-on Top



5" (12.7 cm) Shelf for Back Mounts



5" (12.7 cm) Shelf with Slide-in VESA 75/100 Plate



Welch Allyn Shelf



LCD Head



3" (7.6 cm) Shelf with 30° Tilt Limit



VESA Drop-on Shelf

Mobile Stands

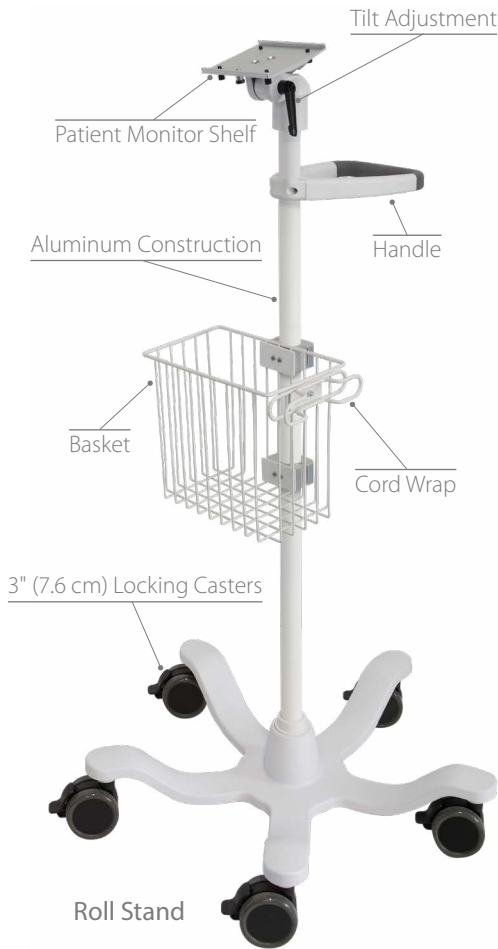

CTM Mobile Cart

Roll Stand Accessories

Soft Grip Handle



Aluminum Base

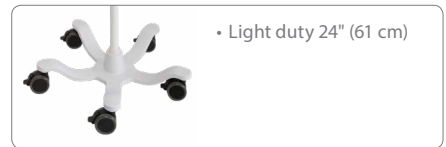

Counterweight

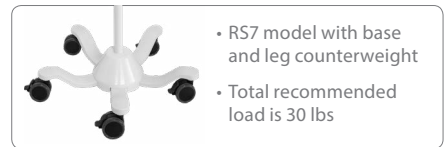

Anodized Aluminum Post

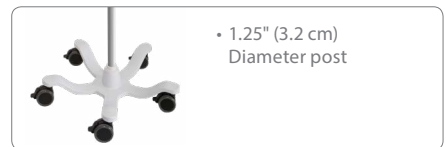

Powder Coated Aluminum Post

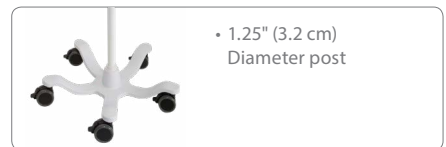

Accessories

iPad/Tablet Mount



Laptop Mount

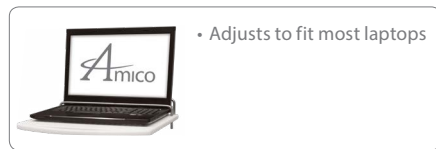

Keyboard Trays



Wire Basket

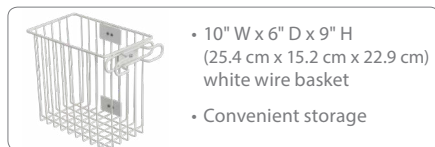

Cord Wrap



Power Holder

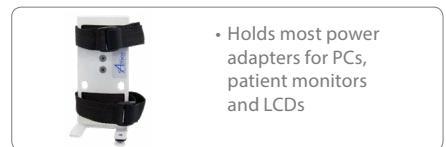

Power Bar



LCD Screen Flush Mount

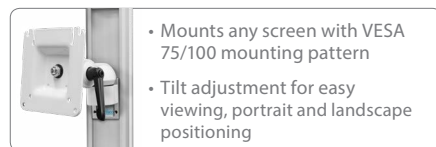

Barcode Holder



Capsule Integration



Capsule Neuron 2 on Direct Mount SSM (Side to Side Mounting Arm)



Capsule Neuron 2 on Flush Vertical Mount SSM



Capsule Neuron 2 on Flush Horizontal Mount SSM



Capsule Neuron 2 on Dual Vertical SSM



Capsule 2 Neuron on Horizontal SSM



Capsule Neuron 2 on Roll Stand



Capsule Neuron 2 on Channel Mount SSM



Accutor Plus Roll Stand Extender



Carescape V100 Roll Stand Extender



Accutorr (Plus or V) Transport Stand Extender



Accutor Plus Value Stand Extender



VS3 Roll Stand Extender



LXi Roll Stand Extender



Connex Roll Stand Extender



Dual SSM Wall Mount



Single SSM Wall Mount



Flush Wall Mount



Vertical DIN Rail and Pole Mount



Horizontal DIN Rail and Pole Mount



Wall Channel



Power Supply Mount



Ultra Flush Pole Mount



Power Supply Pole Mount



Power Supply DIN Rail Mount

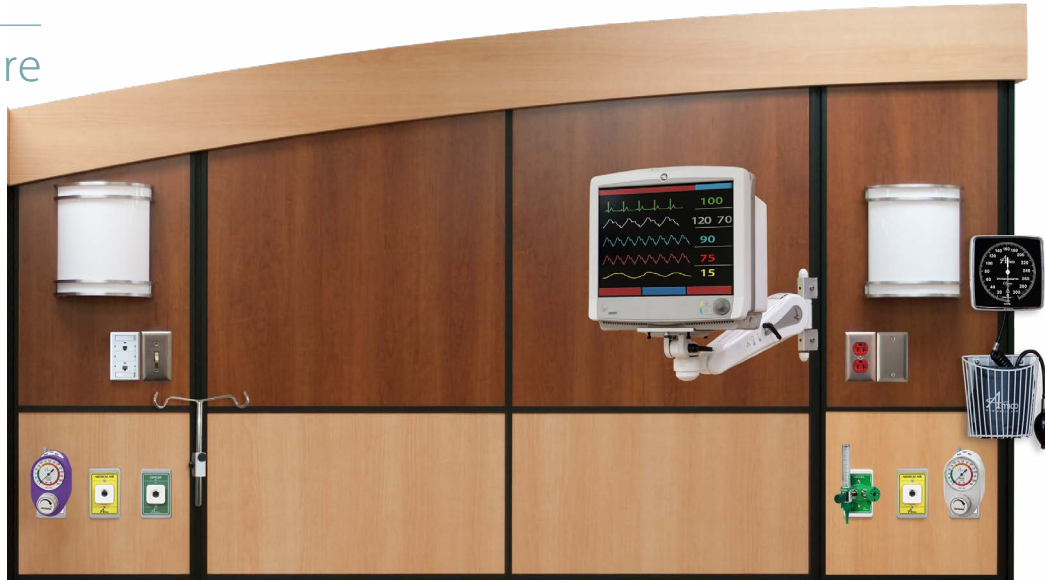

B650 on Direct Mount AHM (Adjustable Height Mounting Arm)



Carescape V100 on Roll Stand



Solar 8000i on AHM



Solar 8000i on AHM with Extension



Dual Tram Rac 4 on Rac Hanger



Single Tram Rac 4, PRN50, PDM on SSM



Solar 8000i Directly on Vertical Rail



Flush 5" (12.7 cm) Shelf for Solar 8000i and Unity Network ID Box

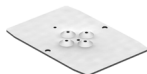

PDM Adapter Plate



8000i Stack Mount Post for LCD Monitor



Remote 8000 Keypad Bracket



B850 F5 Module Hanger



B850 F5 Module Hanger and PRN-50 Printer Mount



Single Tram Rac 4 or 2 Hanger



Dual Tram Rac 4 or 2 Hanger



L Bracket for Tram RAC 4 or 2



L Bracket with Pole Clamp for PDM Module



L Bracket for PDM or PRN50 Digital Writer



Power Supply Mount



IntelliVue MX450
on Direct Mount AHM
(Adjustable Height
Mounting Arm)



IntelliVue MP70
on Direct Mount AHM



IntelliVue MP50
on AHM



IntelliVue MP50
on Direct Mount Horizontal AHM



IntelliVue MP70
on Direct Mount Vertical AHM



SureSigns VM8
on Roll Stand



IntelliVue MP70
on Direct Mount AHM



Pole Clamp for
Philips Speed
Point Remote



Adapter for Philips
Flexible Module Server
(FMS) and Satellite Rack



Power
Supply Mount

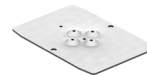

SureSigns VM4, VM6,
VM8, VS3, VS4 and VSV
Adapter Plate



Telemon
Bracket



Cord Hook



Quad Cord
Hooks



Quad Cord Hooks
with Clamp



Quad Cord Hooks
with Downpost



MP90 for Flat Panel Display,
Remote Speedpoint and
External Alert

Dräger

Medical



Infinity Delta on Direct Mount AHM (Adjustable Height Mounting Arm)



Infinity Delta XL with Docking Station on AHM



Infinity C700 on Direct Mount Falcon



Infinity Delta on Direct Mount AHM



Infinity C700 on Direct Mount AHM

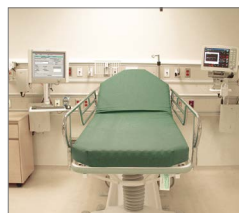

Infinity Omega on Direct Mount AHM



Infinity Delta on Direct Mount Falcon



Infinity C700 Keyboard Tray



Dräger Power Supply Mount



Power Supply Mount for C700

Spacelabs

Healthcare

XPREZZON on Direct Mount SSM (Side to Side Mounting Arm)



SL2600 on SSM With Hanging Module



MCare on Direct Mount AHM

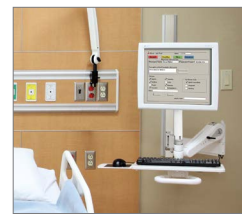

Ultraview SL2800 on Falcon with Extension



XPREZZON on Direct Mount SSM



MCare on Direct Mount AHM



SL2600 on Direct Mount SSM



Dual Power Supply Mount



Power Supply Mount for C700



Dual SL Command Module Hanger



Single SL Command Module Hanger



XPREZZON Hook and Handle Bracket



XPREZZON O Bracket



AUX Module Bracket Next to XPREZZON O Bracket



Plate for 2200, 2400, 2600



MCare Plate



VESA Drop on Shelf for Cube and Elance Monitors

Welch Allyn



CVSM on Roll Stand



300 Series
on Roll Stand



Spot Vital Signs LXI
on SSM



Spot Vital Signs
on SSM



Propaq LT on Dual
Device Mount



Atlas on Direct Mount
AHM



Spot Vital Signs
LXI on Flush Rail
Mount



Propaq Plate with Printer

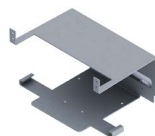

Propaq Plate
without Printer



Atlas Plate

Mindray

Medical



V21 on Direct Mount AHM
(Adjustable Height Mounting Arm)



BeneView T5
on Roll Stand



BeneView T5 on Direct
Mount AHM



Mindray VS800 on Direct
Mount SSM



VS800 Shown on
Mobile Workstation



PM 9800 on Direct
Mount SSM



BeneView T5 on
Roll Stand



VS 800 Plate



PM 7000X Plate



PM 8000X Plate



PM 9000X Plate



T7 Plate



V12 Module
Mounting Kit



T5 Plate



Datascope/Mindray
Accutor Plus Plate



Datascope/Mindray
Passport 2 Plate with
Power Supply Mount

Vital Signs

Amico, Masimo, Cas, Nellcor, Criticare and Suntech



Amico Vital Signs
on Direct Mount AHM
(Adjustable Height
Mounting Arm)



Nellcor OxiMax N-560
on Roll Stand



Masimo Rad-87
on Direct Mount AHM



Cas Monitor 750
on Direct Mount AHM



Masimo Radical-7
on Direct Mount AHM



Nellcor OxiMax N-600X
on Direct Mount SSM



Nellcor OxiMax N-560
on Direct Mount AHM



Criticare 506DN Plate



Criticare 507E Plate



Criticare 8100 Plate



Side to Side
Monitor Arm



Adjustable Height
Monitor Arm



Masimo Radical Plate



Nellcor 600 Plate



Cas 740 Plate

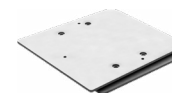

Edan M3 Plate

Nihon Kohden



Nihon Kohden Lifescope G9
on Headwall



Nihon Kohden BSM 3500
on MRS channels



Nihon Kohden BSM 3500
on TTM



Nihon Kohden BSM 3500
on Headwall



Nihon Kohden BSM 6701
on Direct Mount AHM



Nihon Kohden BSM 6701
on Roll Stand



Nihon Kohden Lifescope
G9 on CTM Cart



Nihon Kohden
6501 Plate



Nihon Kohden
Lifescope BSM Plate



Nihon Kohden
CSM 1900 Mount



Nihon Kohden
JA694PA Mount



Nihon Kohden
QI930P Mount



Nihon Kohden
920PA Plate

Anesthesia Mounting Solutions



The Anesthesia cart mounting solutions from Amico optimize space to easily mount equipment, storage or monitoring devices to your existing Anesthesia set ups.

Anesthesia Mounting Features

Cable Management

Discrete and sleek cable management maintains a tidy workspace and encourages excellent infection control.

Custom Solutions

A variety of options are available to integrate multiple monitors, an IT charting station or additional peripherals. We work with your facility to accommodate specific needs and unique requirements.

Pre-Assembled

All of our products come pre-assembled to save you the time and cost that it takes to assemble the units. Simply slide the Dovetail or MRS adapter into the track on the machine.

Improve Flexibility

Increase the range of motion for your IT charting station or patient monitor by adding an extension, but don't compromise the stability. Extensions come in a variety of sizes from 6" to 16" (15.24 cm to 40.64 cm).

Easy to Use

Adjust the IT charting station or patient monitor with one hand while working! All of our height adjustable units are counterbalanced to improve workflow and allow the clinician to focus on patient care.

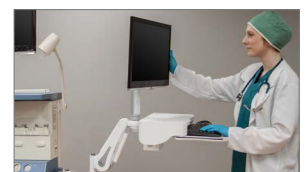

Anesthesia Mounting Products

Falcon IT Station



- 6.5" (16.51 cm) Independent LCD height adjustment
- Entire system easily folds back less than 9" (22.9 cm) for storage when not in use
- Includes both 75/100 VESA mounting options with easy installation slots
- Integrated cable management
- Negative tilt keyboard adjustment
- Easy access to barcode scanner and mouse holders
- 17" (43.18 cm) Overall vertical adjustment range accommodates users of any height
- Locking feature when height has been adjusted
- Counterbalanced to provide effortless movement

Application Examples

Add IT Stations...



- IT station for charting
- CPU Mount
- Height adjustability
- Swivel adjustment
- Portrait orientation for LCD monitor
- Cable management
- Extra writing surface

Add Patient Monitoring...



- Patient monitor
- Recorder unit
- Connector
- Height adjustability
- Swivel adjustment
- Cable management

Anesthesia Machine Compatibility

- GE Avance
- GE Aisys
- GE Aestive
- GE Aespire
- Dräger Primus
- Dräger Narkomed 6000
- Dräger Narkomed 6400
- Dräger Narkomed GS
- Dräger Julian
- Dräger Tiro
- Dräger Fabius OS
- Dräger Fabius MRI
- Dräger Fabius GS
- Dräger Fabius GS Premium
- Dräger Cato
- Dräger Apollo
- Datex Ohmeda Avance
- Datex Ohmeda Aisys
- Datex Ohmeda Aestiva
- Datex Ohmeda Aespire
- Datex Ohmeda ADU
- And more!

Accessories

We offer a number of accessories to help you improve your workflow and ensure you remain comfortable while using technology. Create the perfect patient care area by mixing and matching our accessories with our other product lines. Help promote infection control and keep your environment comfortable and clutter-free.

Single Glove Box Holder



- Universal holder
- Easy to load and mounts to any accessory bar or wall channels

Universal Sharps Holder



- Ideal for mini sharps box and universally compatible
- Easy to load and mounts to accessory bars or wall channels

Hand Sanitizer Holder



- Ideal for personal sized containers
- Easy to load and mounts to any accessory bars or wall channel

Chart Holder



- Temporarily store your charts
- Mount to Amico's accessory bar or wall channel

Hospital Grade Power Bar



- Hospital grade, 4 power outlets
- 120 VAC, 60 Hz

LCD Bumper Handle



- Ergonomic handles can be added to any Amico LCD mount
- Knuckle guard protects walls and user's hands

Barcode Mount



- Universal scanner holders

Keyboard



- Anti-microbial
- Washable and waterproof

Wrist Rest



- Anti-microbial comfort wrist rest
- Virox friendly

Mouse Pad



- Wipeable, self-adhering
- Non-reflecting, ideal for optical mice

Mouse Holder



- Neatly stores mouse when not in use

Dual Cord Hook



- Manage cables, cords and other hanging wires
- Attach to the bottom of any monitor arm

Power Supply Mount



- Holds most power adapters for PCs, patient monitors and LCDs

Dual Power Supply Mount



CPU Mounts



- Available in various sizes

Monitor Handle



- Easy grab handle

Basket with Disk Adapter







- Mount basket directly to any arm
- Available:
 - 5" x 5" x 4" (12.7 cm x 12.7 cm x 10.2 cm)
 - 10" x 10" x 4" (25.4 cm x 25.4 cm x 10.2 cm)
 - 10" x 6" x 9" (25.4 cm x 15.2 cm x 22.9 cm)

Shelf

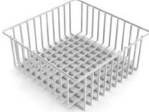

Storage Baskets











- Sterilizable
- Powder coated
- Mount to channel or any rail system

	5" x 5" x 4" (12.7 cm x 12.7 cm x 10.2 cm)	10" x 10" x 4" (25.4 cm x 25.4 cm x 10.2 cm)	10" x 6" x 9" (25.4 cm x 15.2 cm x 22.9 cm)	BP Cuff Basket	Basket Liner 10" x 10" x 4" (25.4 cm x 25.4 cm x 10.2 cm)
					

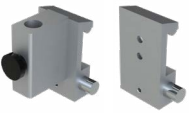

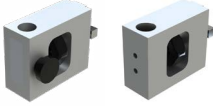
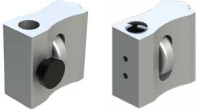
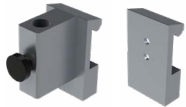
Channels and Rails

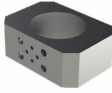
	Channel Covers 	
---	--	---

Rail Adapters

Horizontal Track Adapter 	Vertical Track Adapter 	Direct to Wall or Slide Adapter 	DIN Track Adapter 	Fairfield Track Adapter 
Monitor Channel Adapter 	Dovetail Adapter 	HSI Vertical Rail Adapter 	Hill-Rom Vertical Rail Adapter 	
Fairfield CAM Adapter 	DIN Rotational Pole Clamp 	Amico 50.8mm (2") C Clamp 	Amico 31.8mm (1.25") C Clamp 	

Down Post

	• Available in various lengths		• Available in various heights		• Available in various heights
---	--------------------------------	---	--------------------------------	---	--------------------------------



Amico Accessories Inc. | 85 Fulton Way, Richmond Hill, ON L4B 2N4, Canada
Toll Free Tel: 1.877.264.2697 | Tel: 905.763.7778 | Fax: 905.763.8587
Email: info@amico-accessories.com | www.amico.com

Represented By: